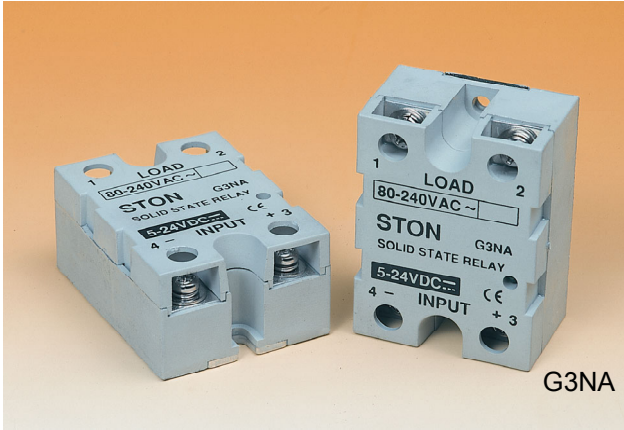

**STON****SOLID STATE RELAY****固態繼電器**

- CE Approved .
- Varistor and RC inside can protection load.
- Load current has 12A/25A/40A.
- Input has LED to display ON state.
- CE 認證,外觀為歐洲規格具防觸保護。
- 內部採用突波吸收器及 RC 吸收器。
- 負載電流具有三種規格 12A/25A/40A。
- 輸入具有 LED 顯示。

### ◦ ORDERING INFORMATION 訂購說明

Ex. G3NA **D** **A** **25**

Input voltage 激發電壓	Output voltage 輸出電壓	Operating voltage 電壓範圍
D: DC 5~24V M: AC/DC24~240V R: VR(EXTERNAL)	D: DC5~60V A: AC24~240V AH: AC200~480V	12: 12A 25: 25A 40: 40A

- If Output voltage is DC100~200V that Operating current must selection 12A. 輸出電壓若為 DC100~200V 則操作電流須為 12A
- Output current must more than 1A. 輸出電流必須大於 1 安培。

### ◦ SPECIFICATIONS & CHARACTERISTICS 規格 & 特性

Type 型式	G3NA			
Operating voltage range 電壓使用範圍	D 系列: DC3~32V		M 系列: AC/DC19~260V	
Rated trigger capacity 額定觸發功率	Under 0.2VA			
Rated frequency 額定頻率	AC: 50~60Hz			
Minima ON/OFF voltage 啟動、釋放電壓	ON: 2.8V	OFF: 1.5V	ON: 13V	OFF: 9V
Rated output current 輸出電流	12A / 25A / 40A P.F.=1			
Output control mode 輸出控制模式	Zero cross trigger			
Reset time 復歸時間	Less than 0.1s			
Output leakage 漏電流	About 10 mA			
Dielectric strength 耐電壓	2500VAC 50/60Hz 1 Min			
Output arrangement 輸出方式	Out 1 form a			
Max. temperature rise 最大溫升	65 deg.			
Ambient temperature 周圍溫度	-20°C to +80°C 但不結冰結露 But no ice			
Ambient humidity 周圍溼度	Max. 85% RH			
Weight 重量	About 130g			

## ◦ DIMENSIONS 規格尺寸

G3NA

UNIT :mm

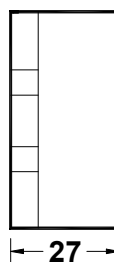
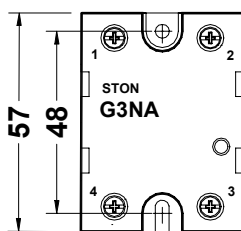

Housing material 外殼材質 : PBT

## ◦ OPERATION 操作方式

### G3NA-DA □

Single phase 單相

Three phase 三相(控制 R S T 三相 Control 3 phase)

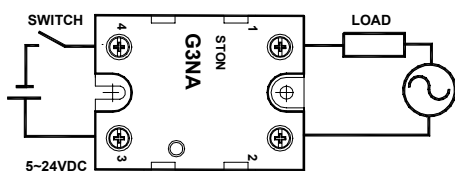

Three phase 三相(控制 R T 兩相 Control 2 phase)

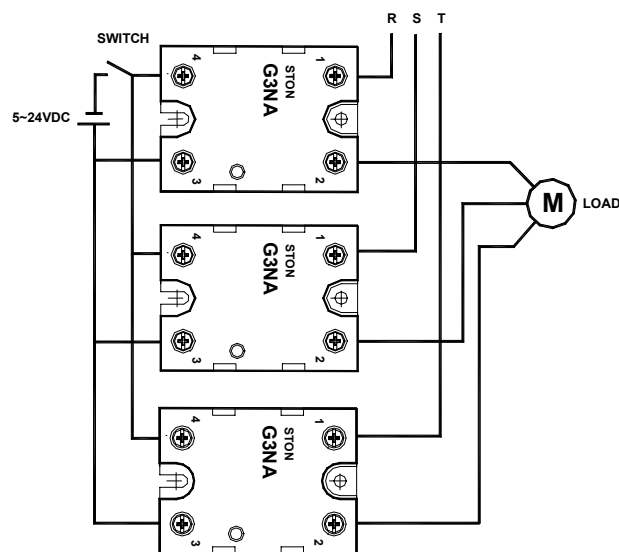
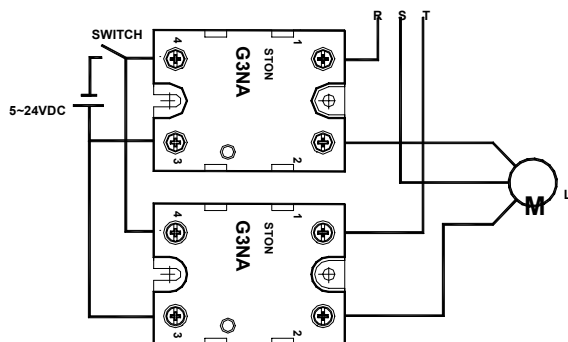

### G3NA-MA □

Single phase

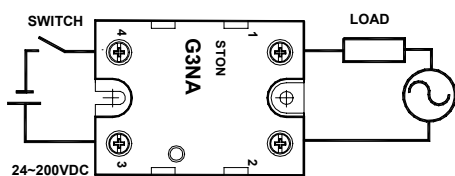

OR

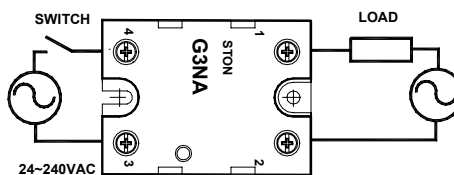

Three phase 三相 請參考 G3NA-DA 接法(Reference G3NA-DA □ three phase)

◦ OPERATION 操作方式

G3NA-RA □

Single phase 單相

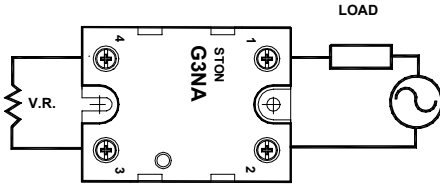

OUTPUT SOURCE=110VAC V.R.=100K  
 OUTPUT SOURCE=220VAC V.R.=250K  
 OUTPUT SOURCE=380VAC V.R.=390K  
 OUTPUT SOURCE=440VAC V.R.=500K

依照不同輸出電壓決定可調式電阻  
 (choice variable resistance by output voltage)

Scale name plate 刻度盤

Type:SCA-1



Rotate cover 旋鈕

Type:SRC-1 (20mm) /SRC-2 (27mm)



NOTE: ◦ If output surge current too large please set 1/1000 fuse  
 ◦ 若輸出之突波電流太大請使用 1/1000 保險絲。

◦ CURVES OF CHARACTERISTIC 負荷電流曲線

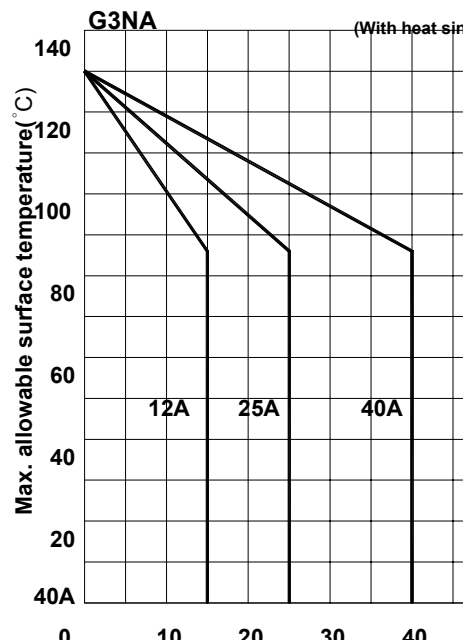
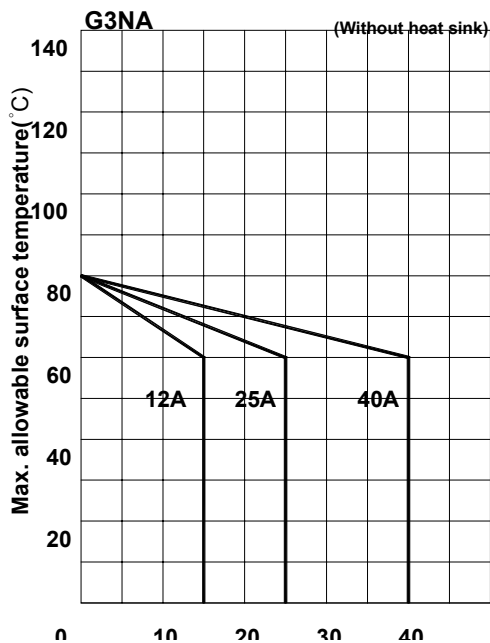

DIMENSIONS 規格尺寸

Heat sink for G3NA  
Type: SHS-50

UNIT :mm

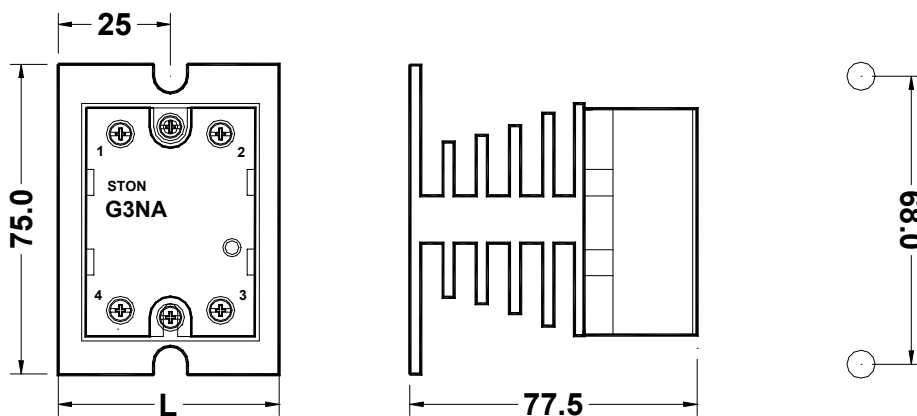

Heat sink material 散熱座材質 : Aluminum 鋁

ORDERING INFORMATION for Heat sink SHS-□□

Model	Pcs for SSR	L (mm)	Max. capacity for SSF
SHS-50	1	50	1
SHS-100	2	100	2
SHS-150	3	150	3
SHS-200	4	200	4
SHS-250	5	250	5
SHS-300	6	300	6

SHS-□□ Heat sink 散熱座

GTHS-1 Conduction Pad 散熱墊片

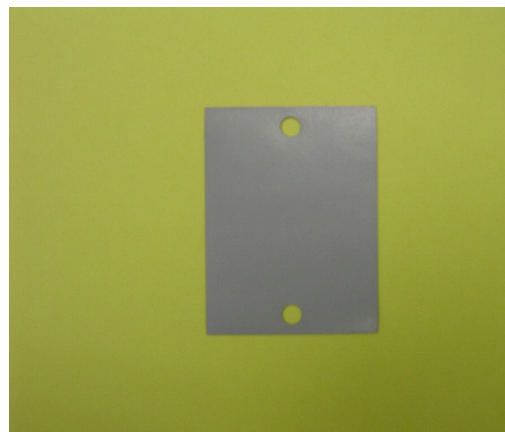
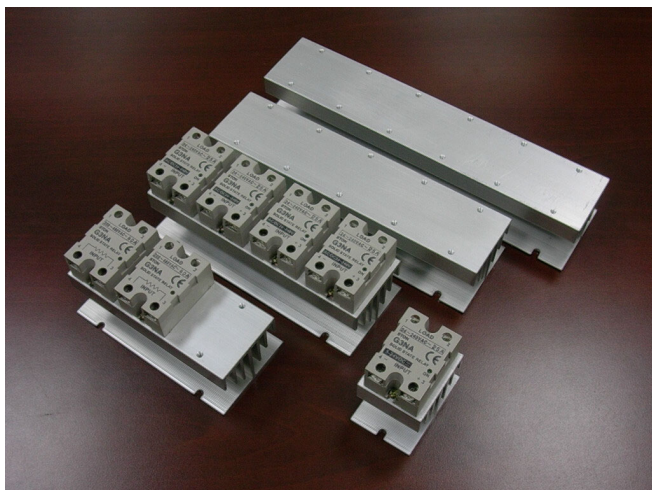

L 長 W 寬 H 高 : 57 X 43 X 0.5 mm

Note: G3NA with SHS between us GTHS-1.(for Heat sink has good efficiency)  
若要有較好的散熱效率應於 G3NA 和 SHS 之間加入散熱墊片 GTHS-1.